

目 录

一、运输作业组织与管理模块..... 2

二、仓储与配送作业组织与管理模块..... 34

三、国际物流作业组织与管理模块..... 150

四、 快递物流作业组织与管理模块.....	213
-----------------------	-----

湖南商务职业技术学院物流管理专业学生技能考核题库

一、运输作业组织与管理模块

○

○

○

--	--	--

○

○

--	--	--	--	--

() 任务描述

- :
-
-



<input type="checkbox"/> <input type="checkbox"/>				<input type="checkbox"/> <input type="checkbox"/>				
<input type="checkbox"/> <input type="checkbox"/>								
						<input type="checkbox"/> <input type="checkbox"/> <input type="checkbox"/> <input type="checkbox"/>		



() 任务描述:

-
-
-



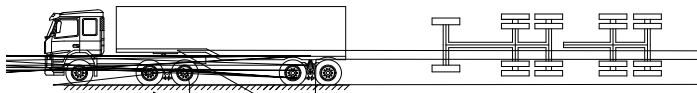
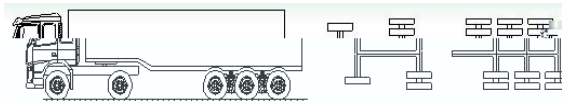

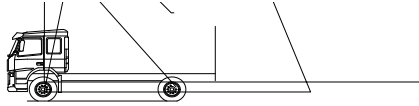
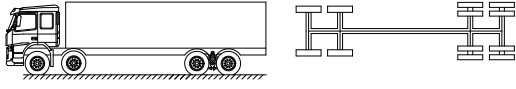
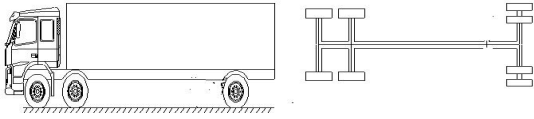

() 任务描述:

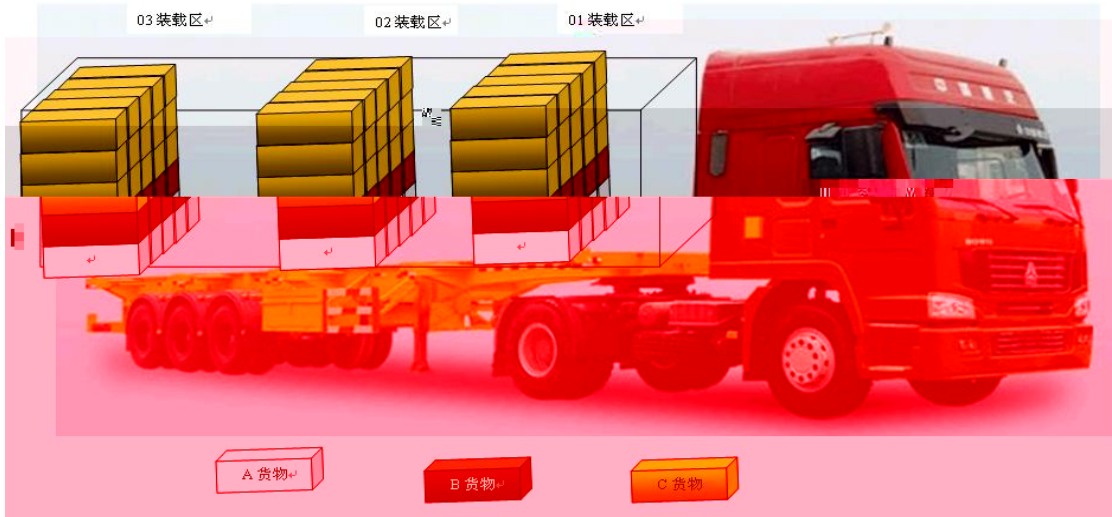

○

○

○

○

○



D

<input type="checkbox"/> <input type="checkbox"/>			<input type="checkbox"/> <input type="checkbox"/>						
<input type="checkbox"/> <input type="checkbox"/>									
						<input type="checkbox"/> <input type="checkbox"/> <input type="checkbox"/> <input type="checkbox"/>			



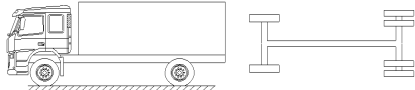
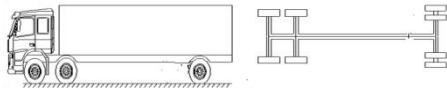
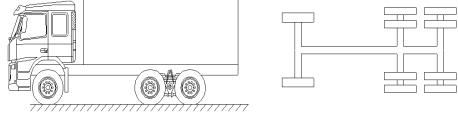

2

3

4

() 任务描述



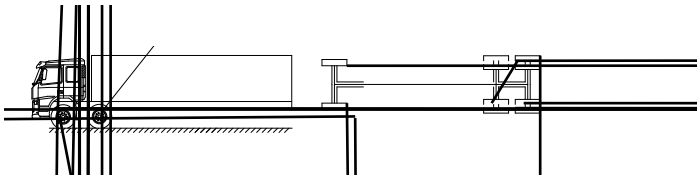
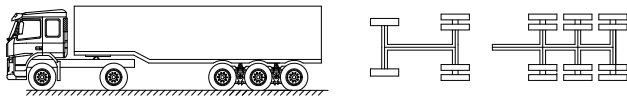
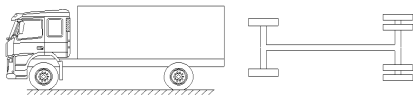



() 任务描述

-
-
-
-
-

() 任务描述

()

()

)	()		

()

()

()

()

()

○

()		

Sailing Schedule from : Shenzhen,Shenzhen,Guangdong,China

To : Los Angeles,Los Angeles,CA,United States

Origin City : Shenzhen,Shenzhen,Guangdong,China

Destination City : Los Angeles,Los Angeles,CA,United States

CY/DOOR

CY/DOOR

序号	航线	船名	航次	截关时间	装货港	预计离港时间	实际离港时间	卸货港
1	YPSW	YM UNISON	59E	2016-04-22 17:00	Yantian	2016-04-25		Los Angeles
2	SEA	NORTHERN JAVELIN	002E	2016-04-23 12:00	Yantian	2016-04-27		Long Beach
3	AAS2	CMA CGM LIBRA	095TXE	2016-04-25 16:00	Yantian	2016-04-28		Long Beach
4	YPSW	YM UBIQUITY	22E	2016-04-29 17:00	Yantian	2016-05-02		Los Angeles
5	SEA	C SCL PUSAN	117E	2016-04-30 12:00	Yantian	2016-05-04		Long Beach
6	AAS2	CMA CGM COLUMBA	097TXE	2016-05-02 16:00	Yantian	2016-05-05		Long Beach
7	SEA	COSCO NINGBO	069W	2016-05-06 11:00	Yantian	2016-05-08		Long Beach
8	YPSW	YM UBERTY	50E	2016-05-06 17:00	Yantian	2016-05-09		Los Angeles
9	SEA	COSCO EXCELLENCE	027E	2016-05-07 12:00	Yantian	2016-05-11		Long Beach
10	AAS2	CMA CGM CENTAURUS	099TXE	2016-05-09 16:00	Yantian	2016-05-12		Long Beach
11	YPSW	YM MASCULINITY	32E	2016-05-13 17:00	Yantian	2016-05-16		Los Angeles
12	SEA	HONG KONG BRIDGE	039E	2016-05-14 12:00	Yantian	2016-05-18		Long Beach
13	AAS2	CMA CGM THALASSA	101TXE	2016-05-16 16:00	Yantian	2016-05-19		Long Beach



干货箱



	箱体内部尺寸			箱体内容积及载重量		箱门开度尺寸	
	L	W	H	Cu	P	W	H
20'	5898	2352	2393	33.2	21740/28230#	2340	2280
40'	12032	2352	2393	67.7	26630	2340	2280
HC	12032	2352	2698	76.3	26520	2340	2585

冷藏箱



	箱体内部尺寸			箱体内容积及载重量	
	L	W	H	Cu	P
20'	5444	2284	2267	28.5	21135/27160#
40'	11583	2284	2250	58.7	26580

	箱体内部尺寸			箱体内容积及载重量	
	L	W	H	Cu	P
20'	5444	2284	2267	28.5	21135/27160#
40'	11583	2284	2250	58.7	26580

○

○

() 实施条件

() 考核时量

() 评分细则

1

() 任务描述



		<input type="checkbox"/>	<input type="checkbox"/>	<input type="checkbox"/>	<input type="checkbox"/>

<input type="checkbox"/> <input type="checkbox"/> <input type="checkbox"/> <input type="checkbox"/>							

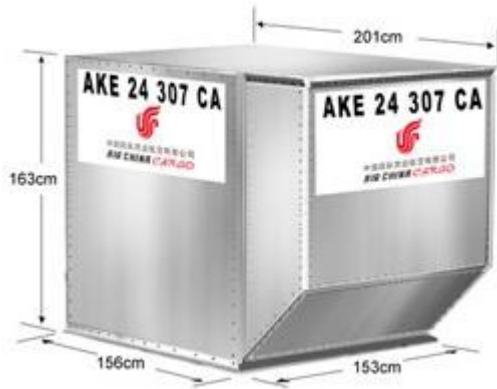

() 实施条件

() 考核时量

() 评分细则

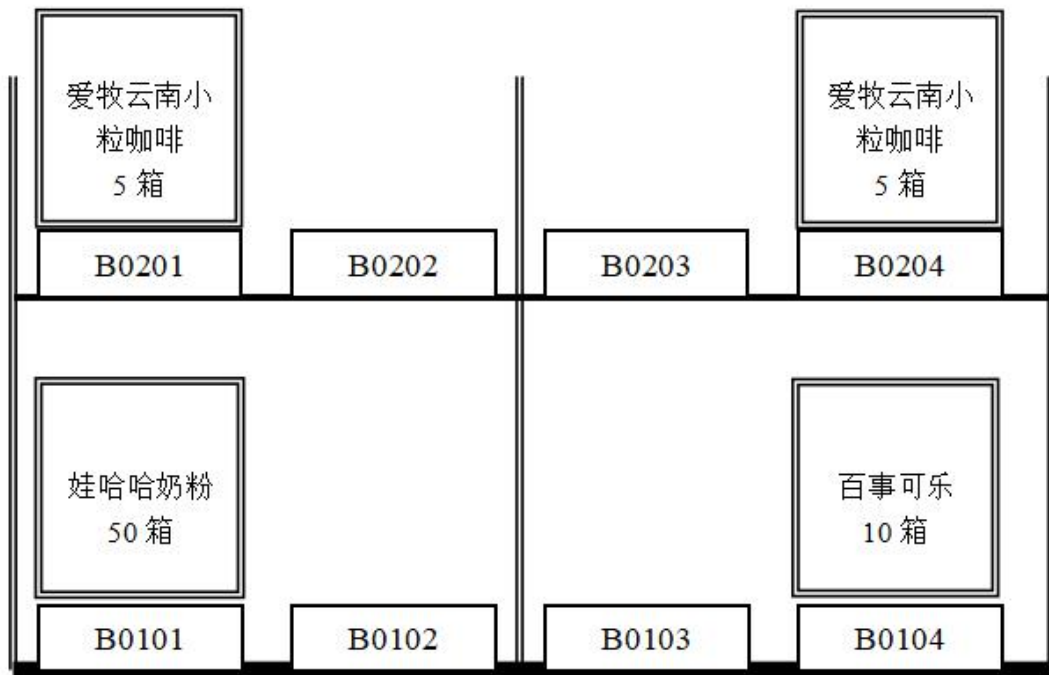
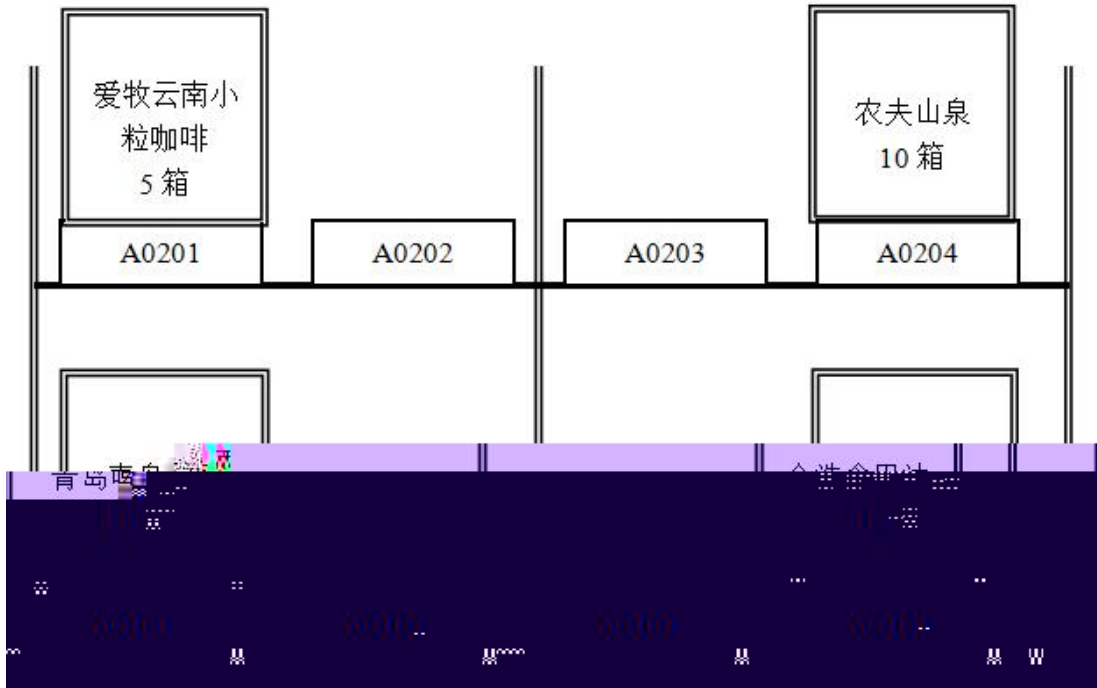

产品运输单

-
-
-
-
-
-
-
-

80				

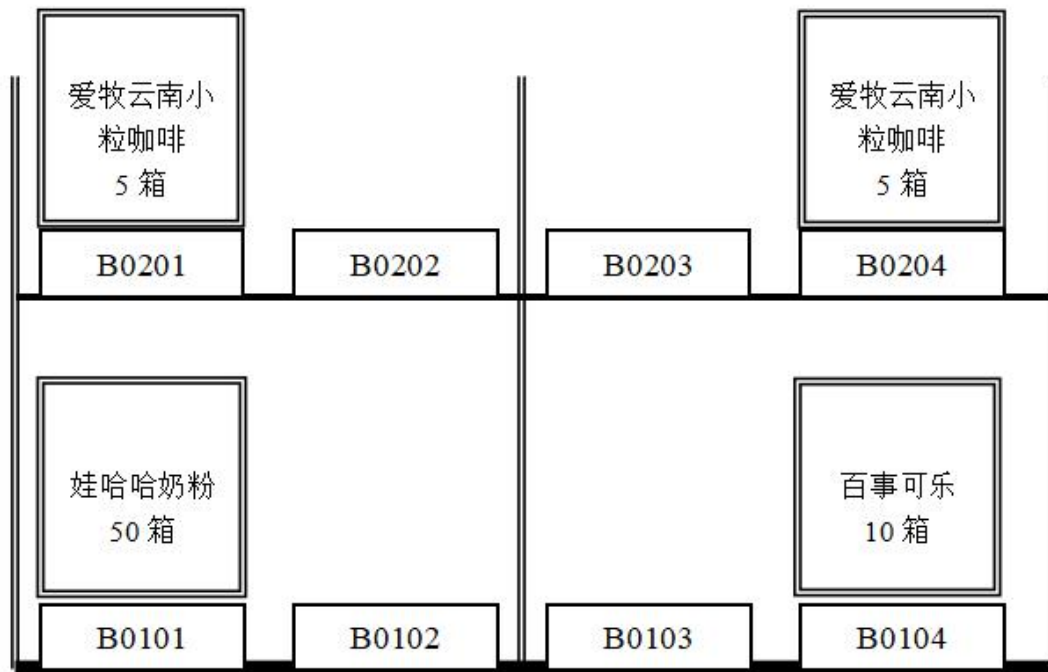
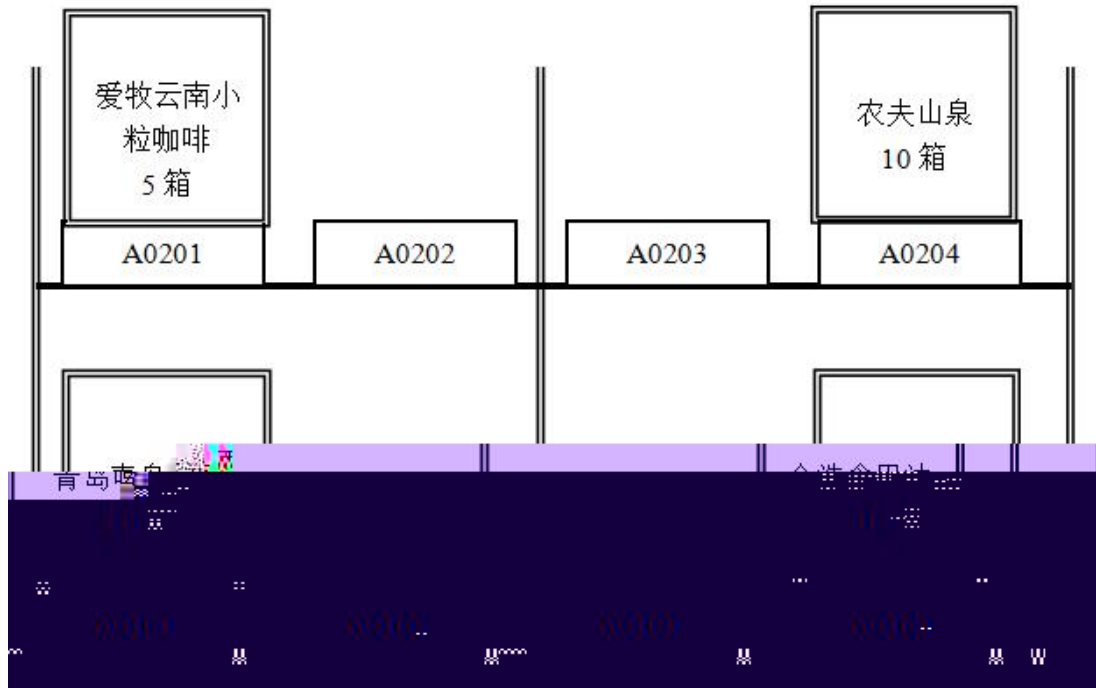

产品运输单

-
-
-
-
-
-
-
-

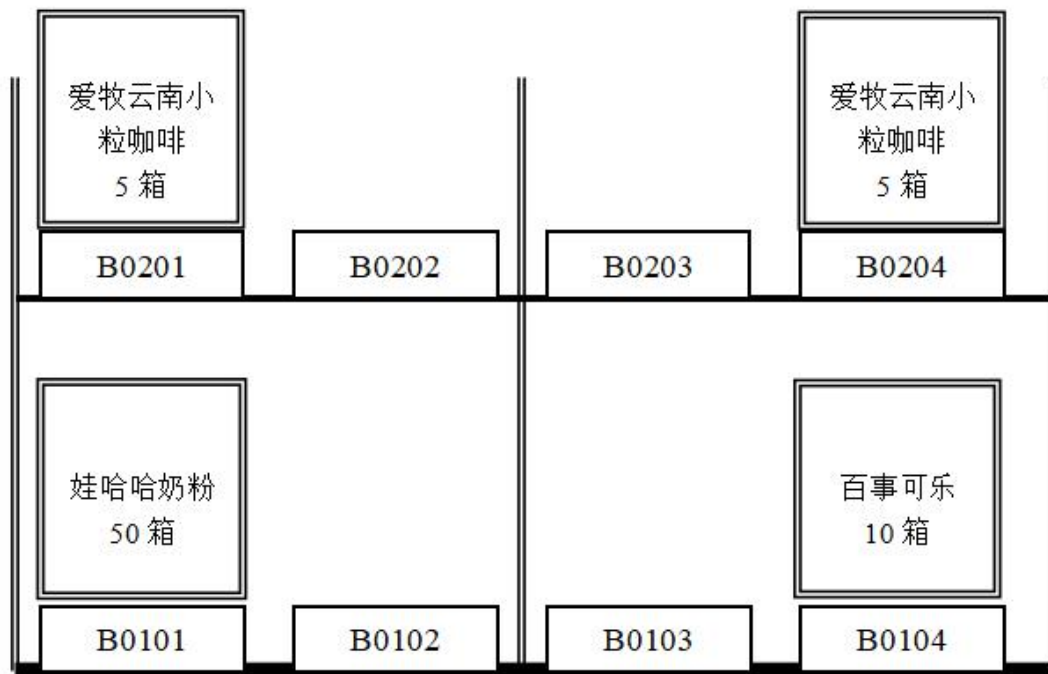
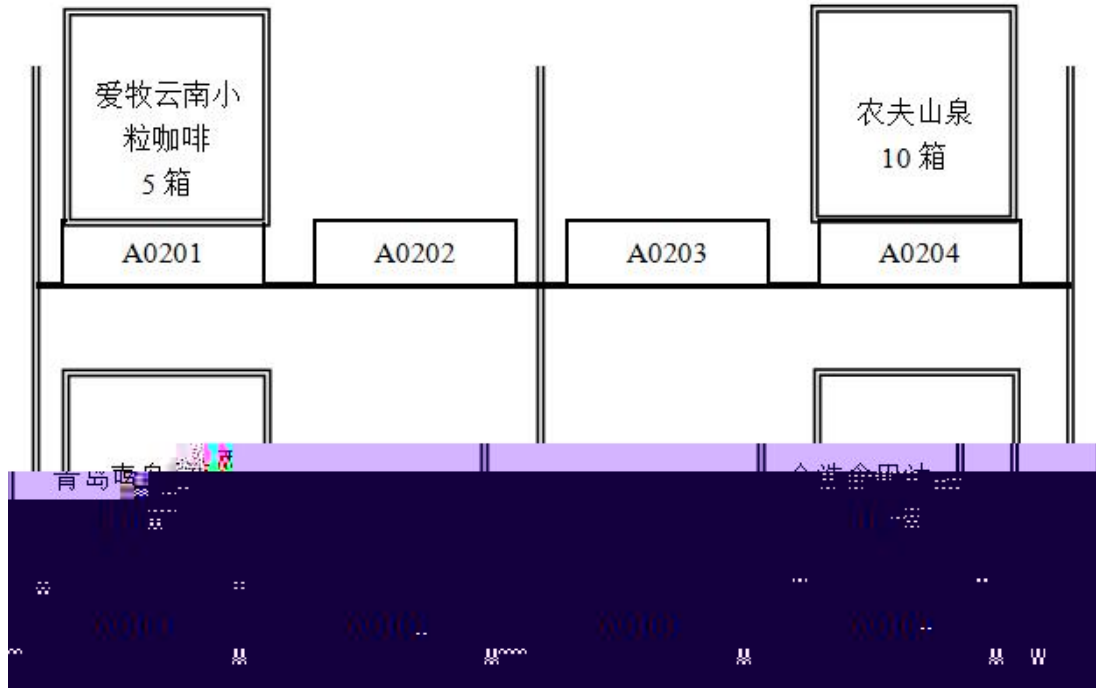

产品运输单

-
-
-
-
-
-
-
-



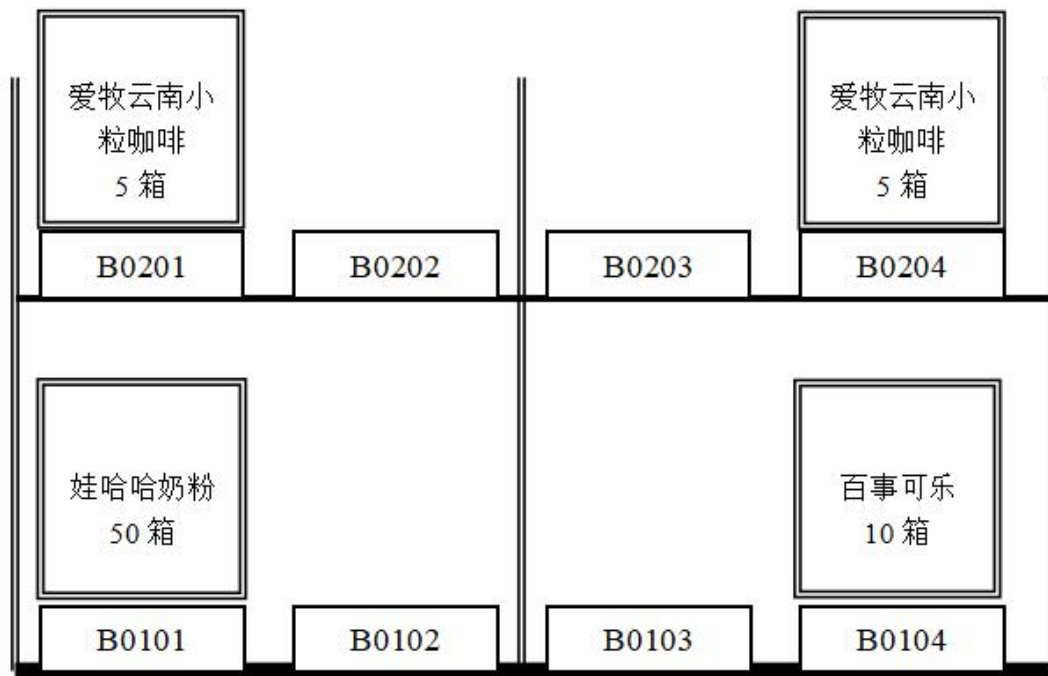
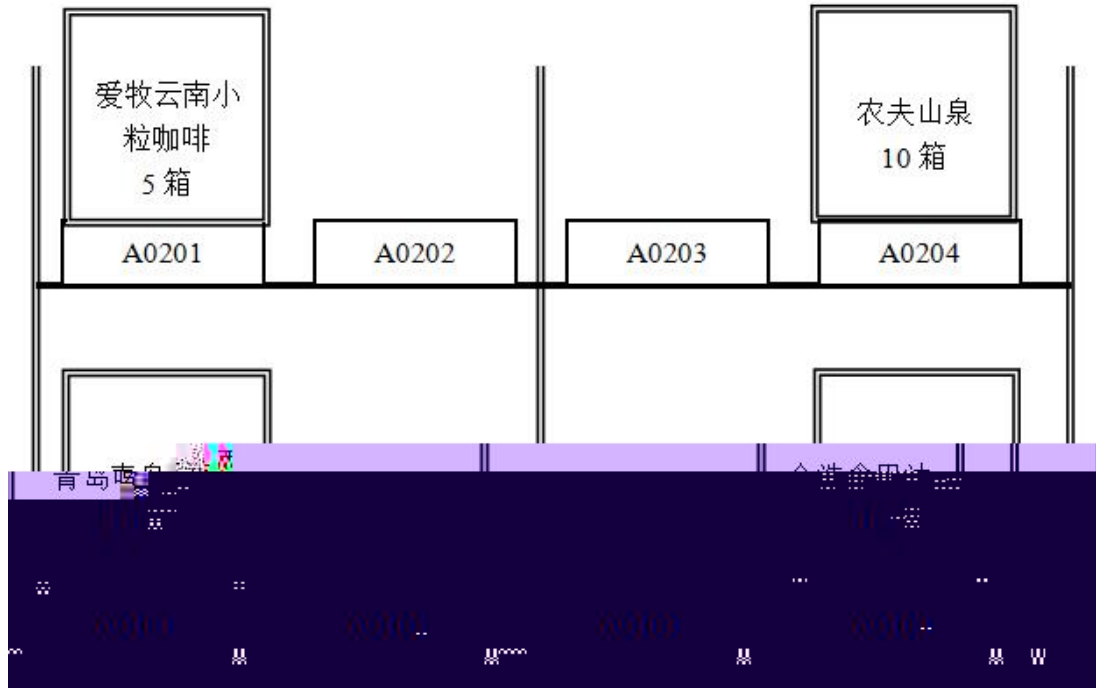

产品运输单

-
-
-
-
-
-
-
-

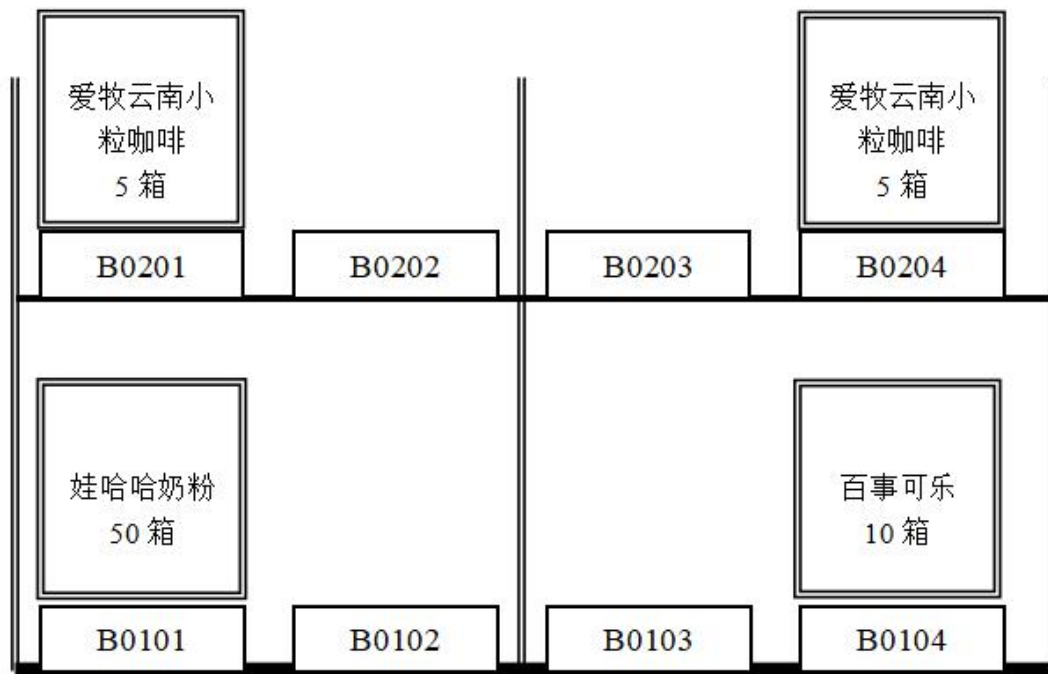
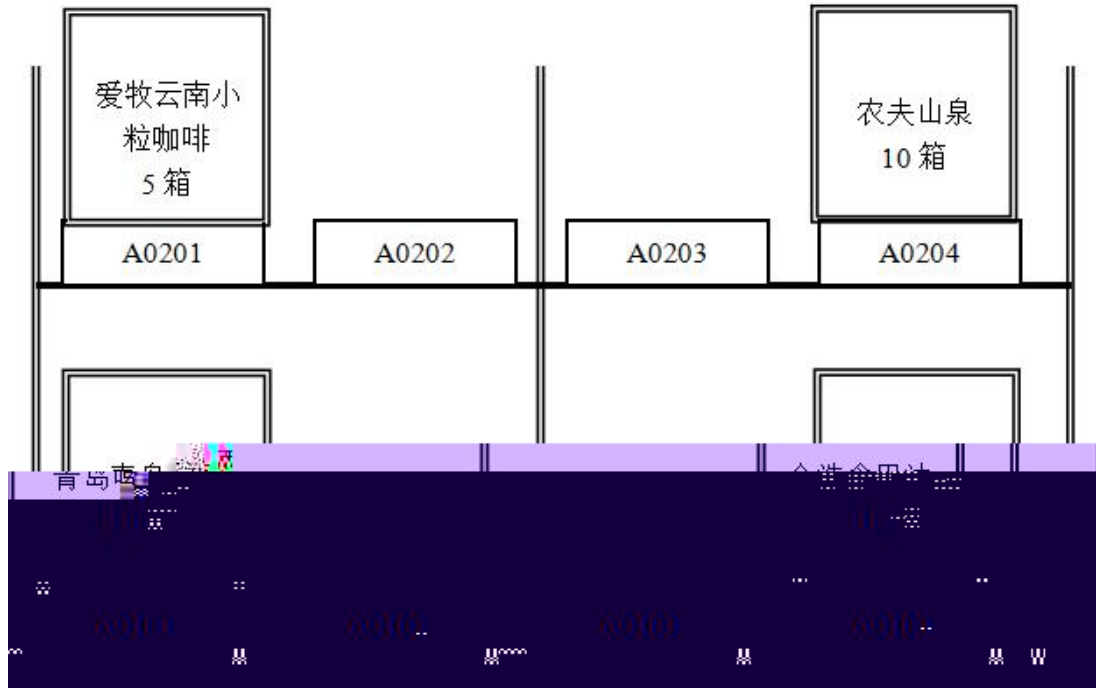

产 输单

Â6\$ ǒ



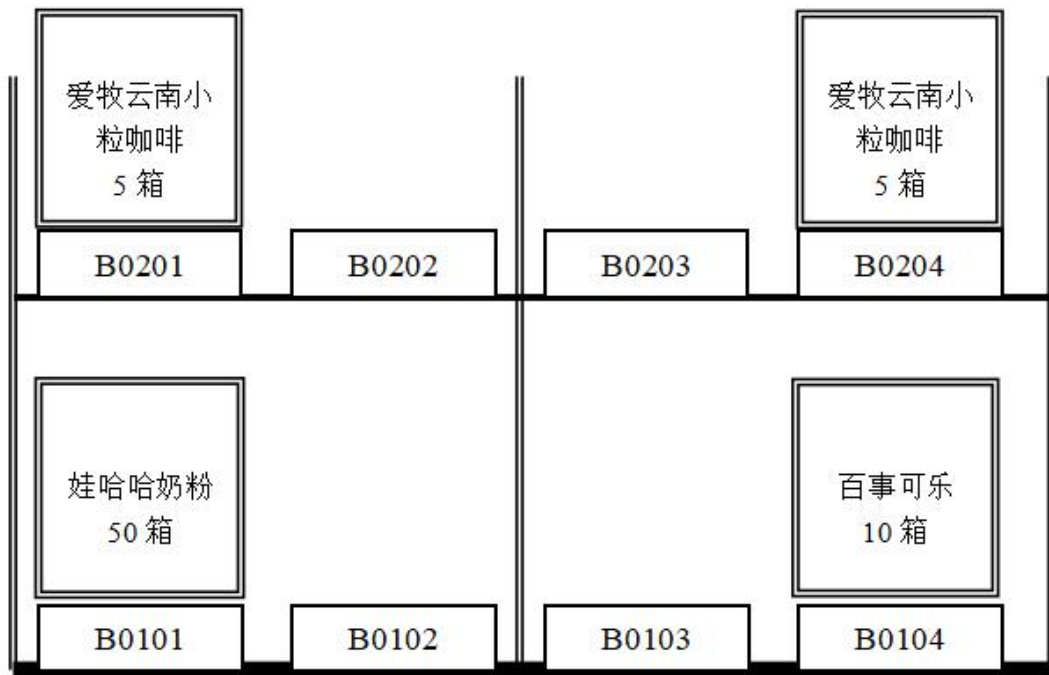
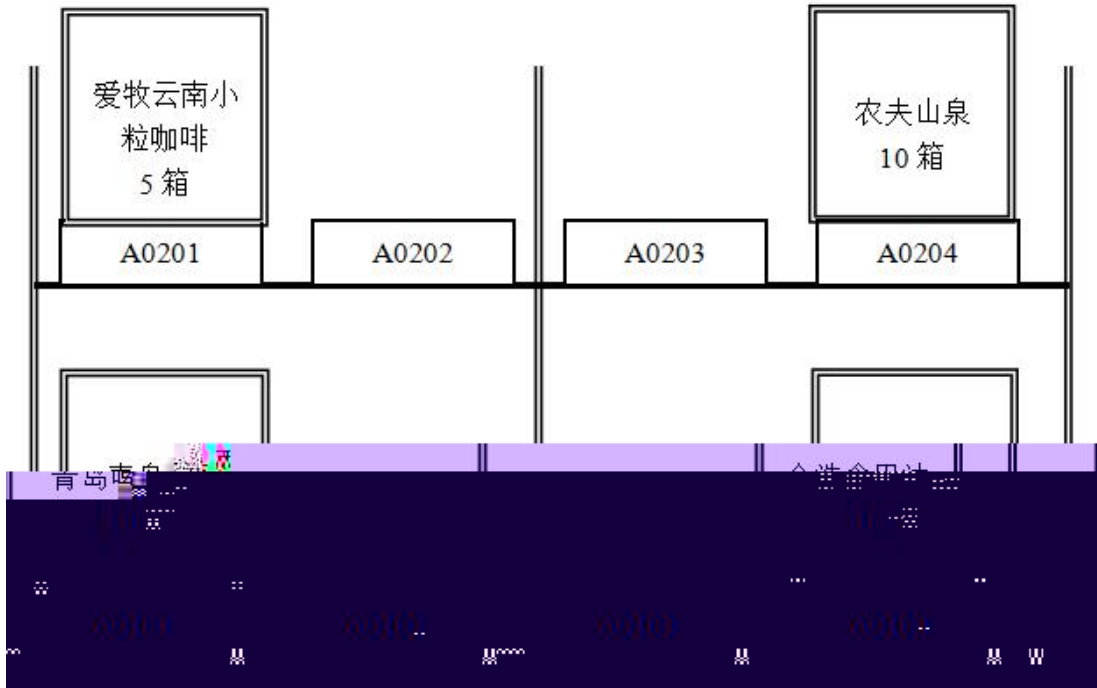

产品运输单

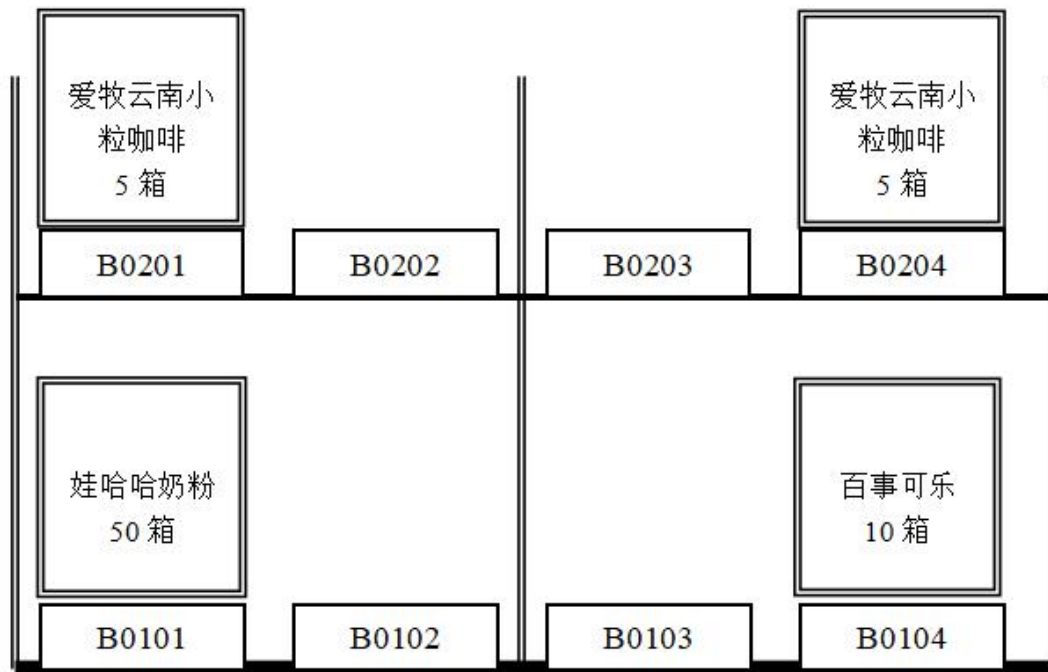
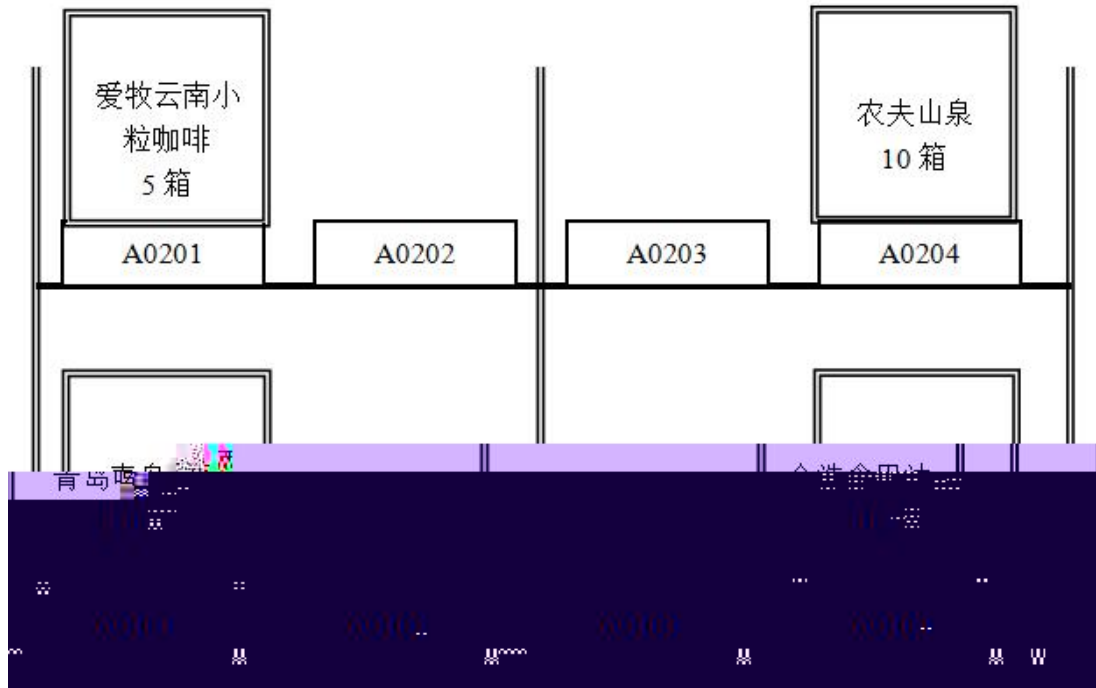

产品运输单

-
-
-
-
-
-
-
-
-

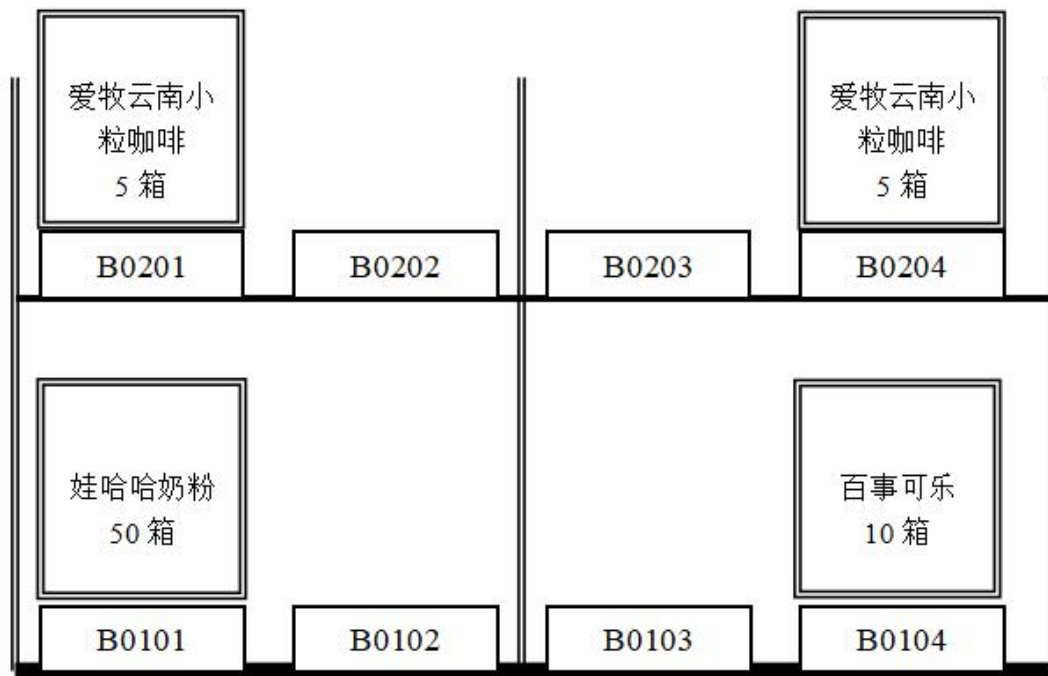
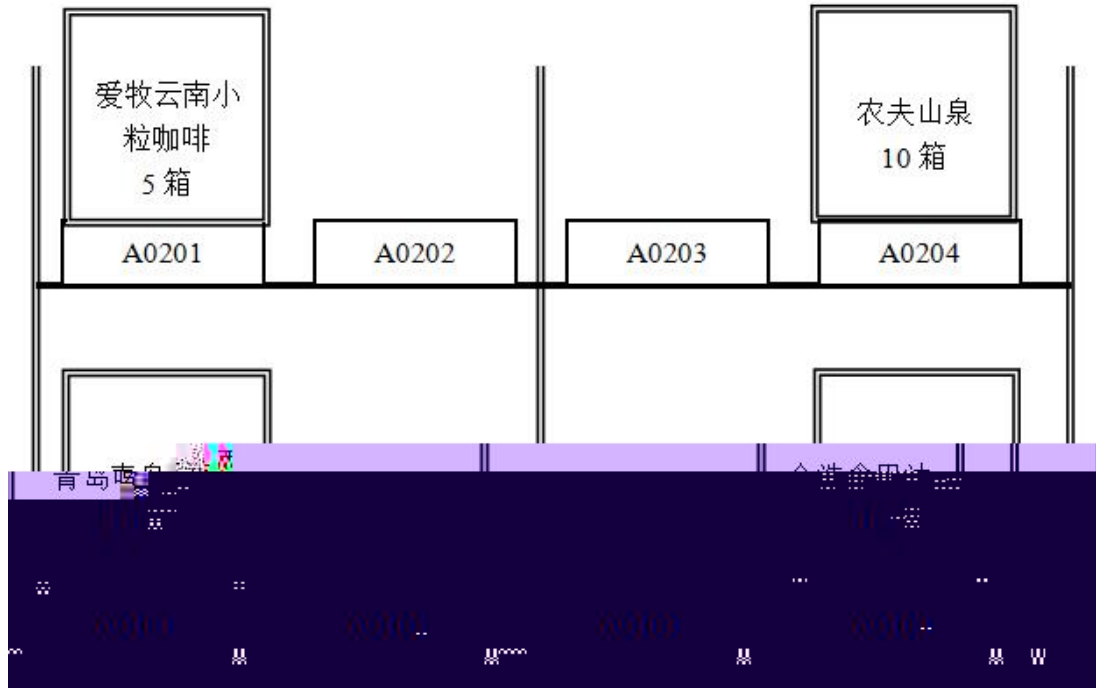

产品运输单

-
-
-
-
-
-
-
-
-

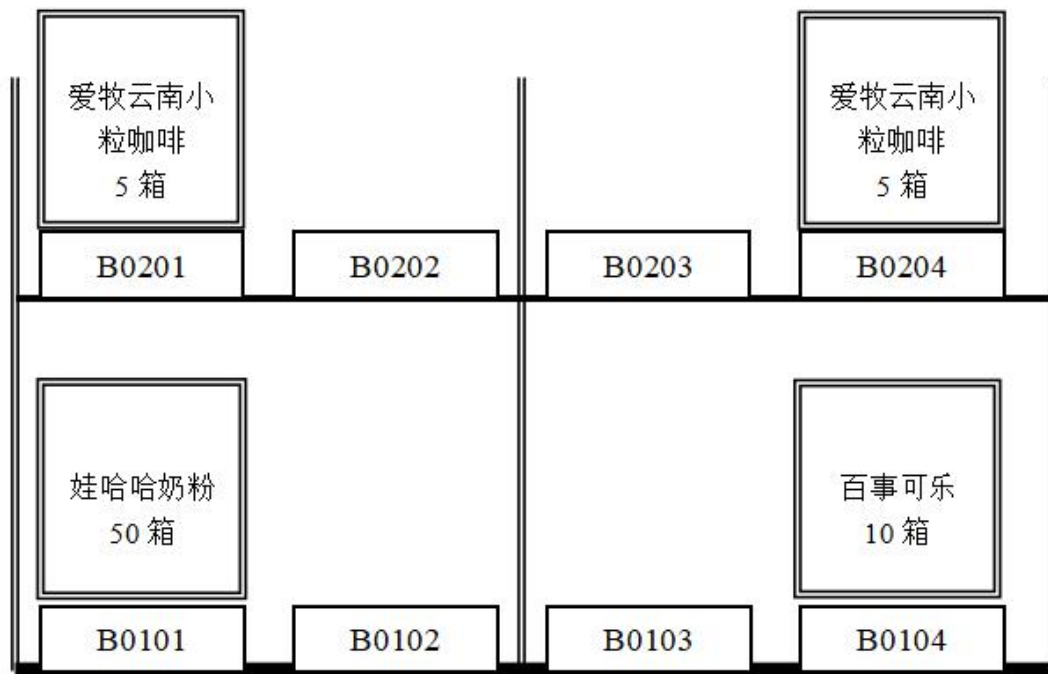
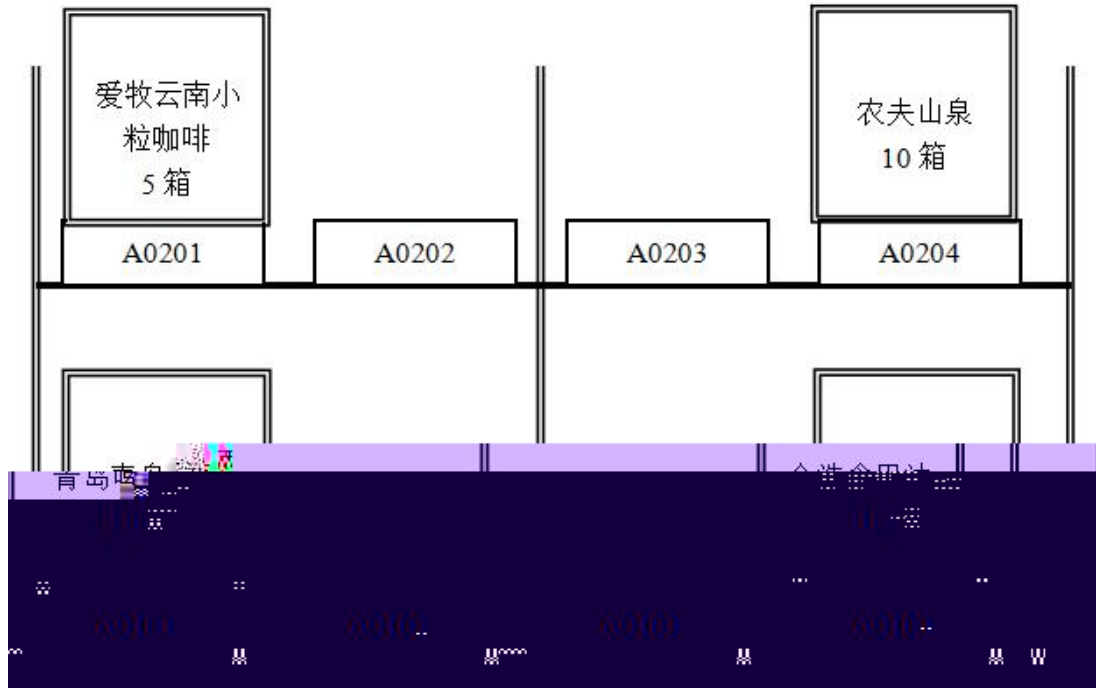

产品运输单

-
-
-
-
-
-
-
-

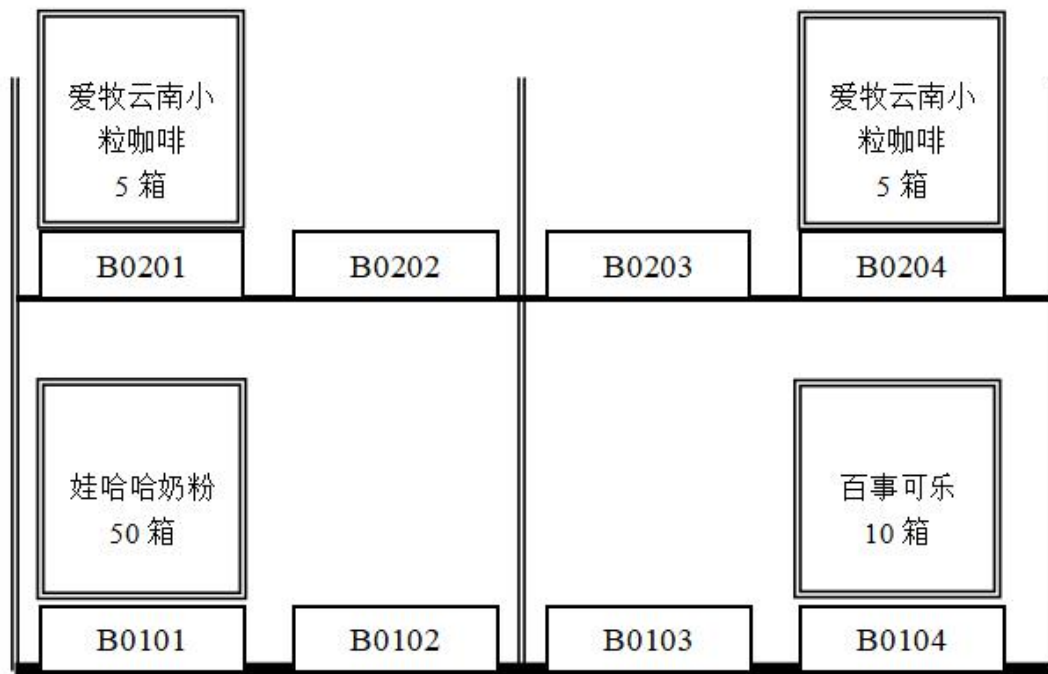
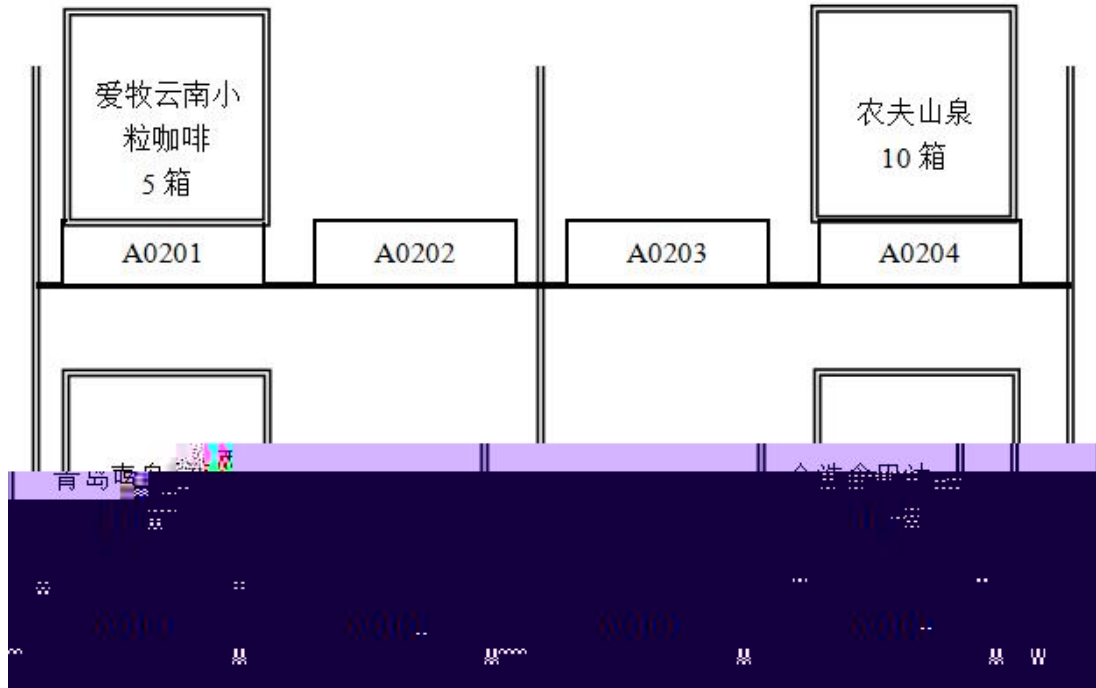

产品运输单

-
-
-
-
-
-
-
-

○

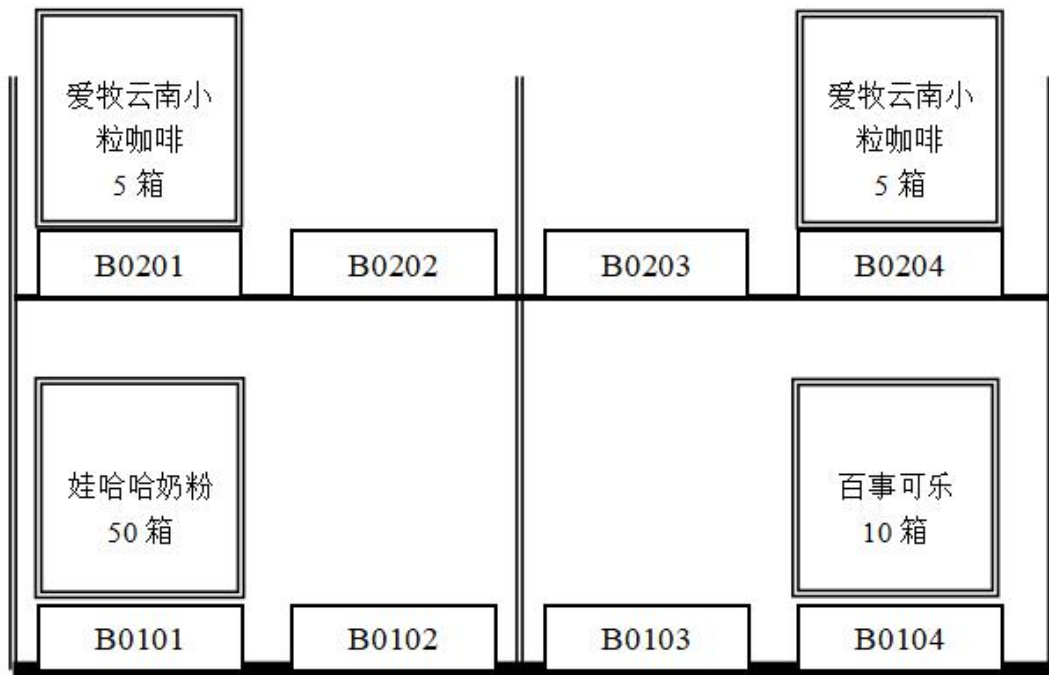
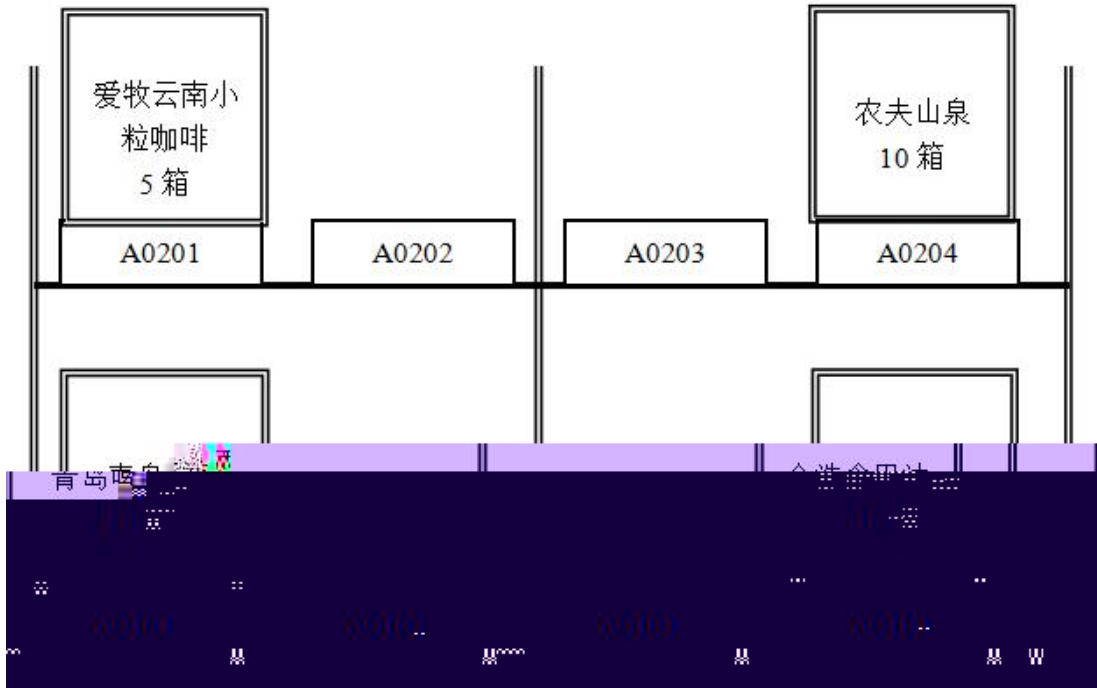



--	--	--	--	--	--

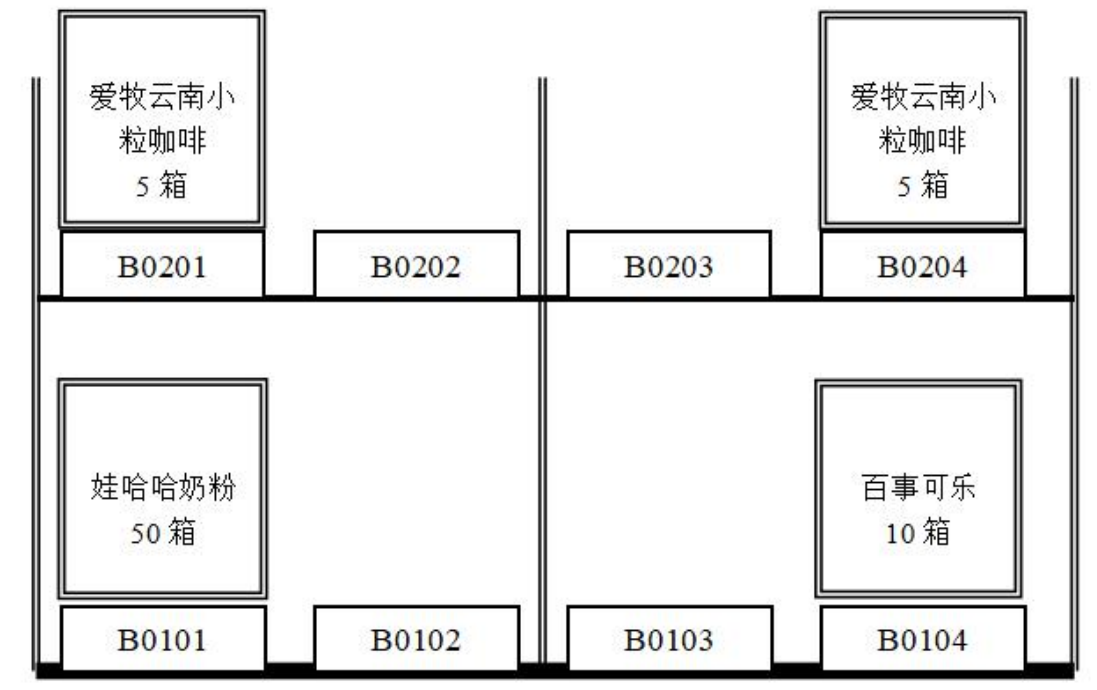
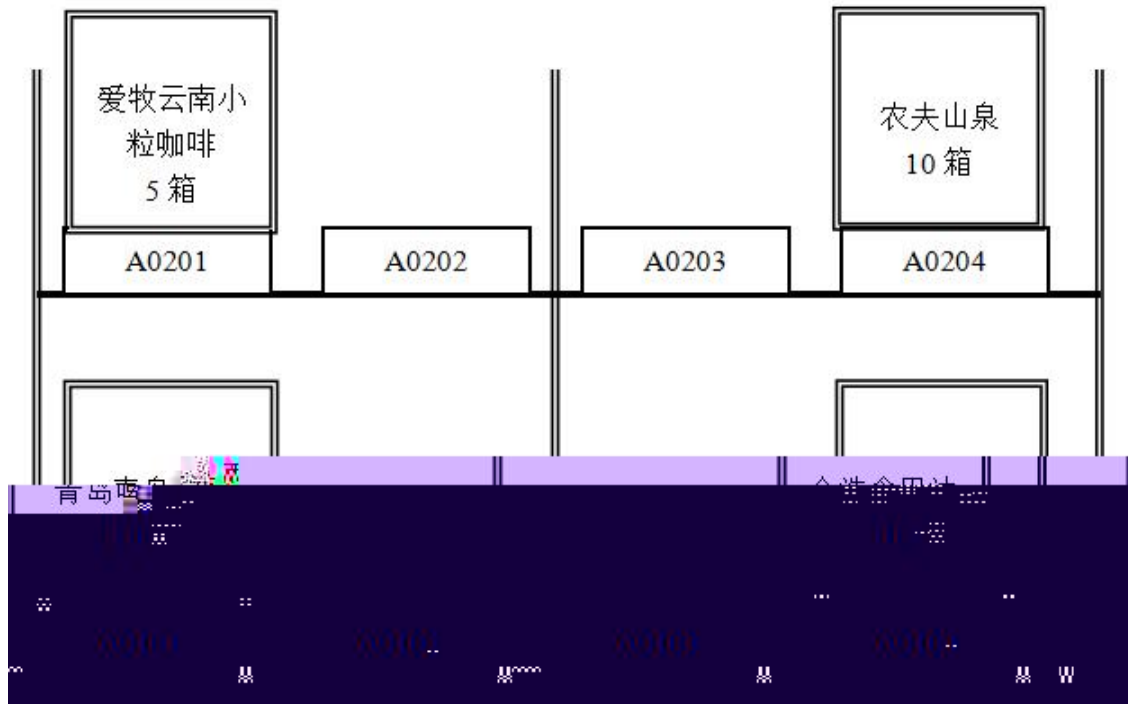

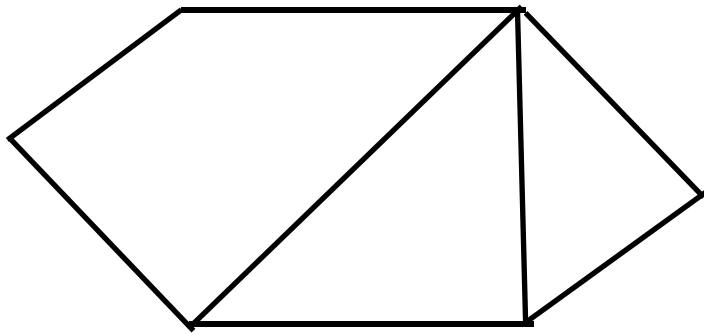

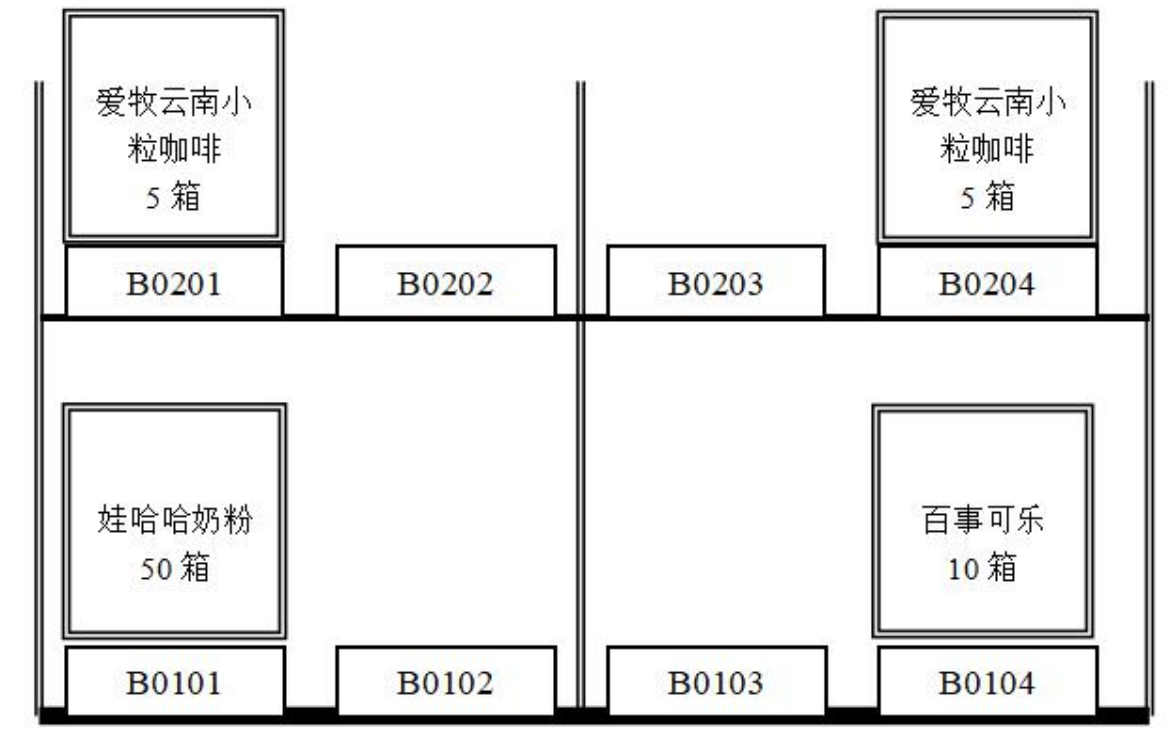
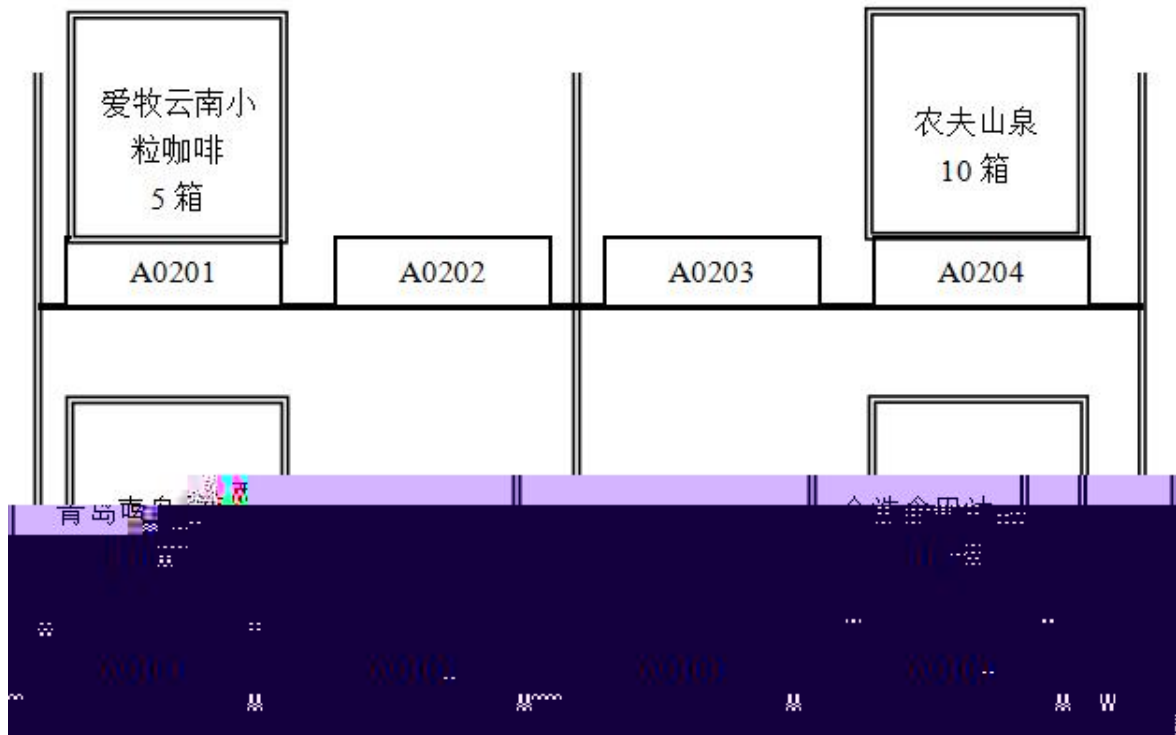

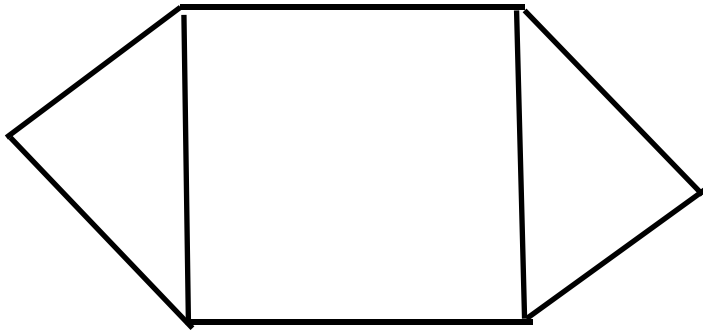

1

		---	---		

		---	---		

--	--

--- ---

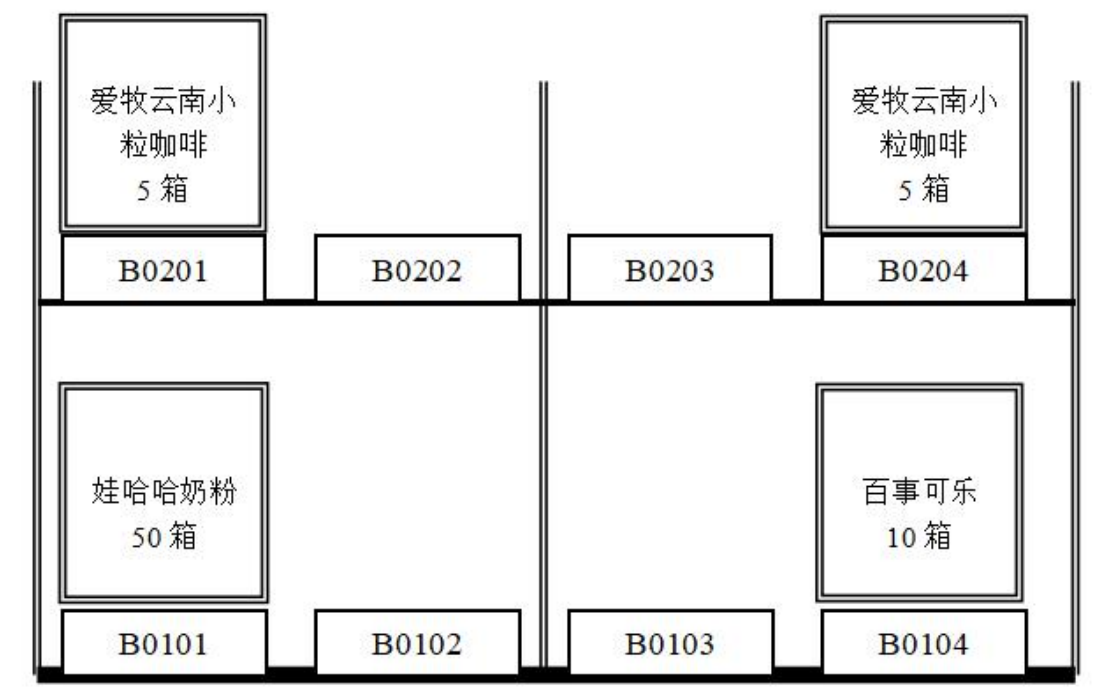
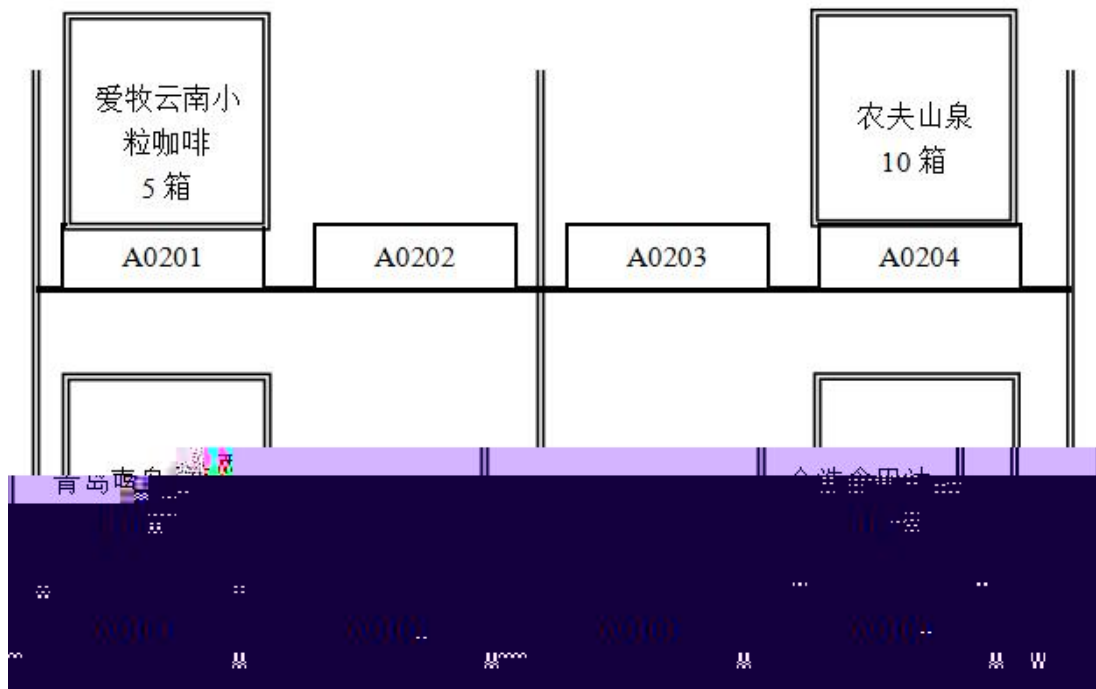

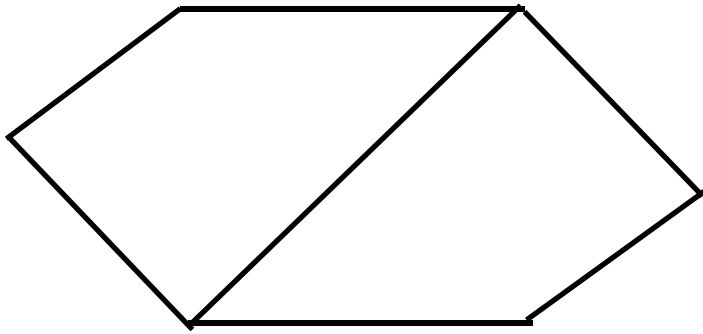

1

--	--	--	--	--	--

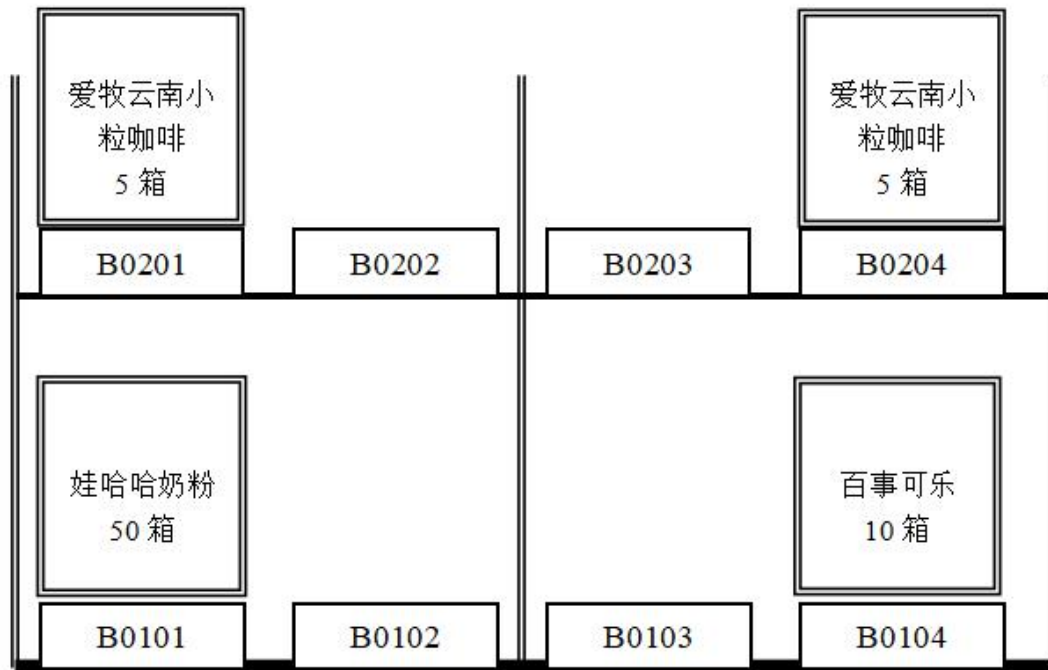
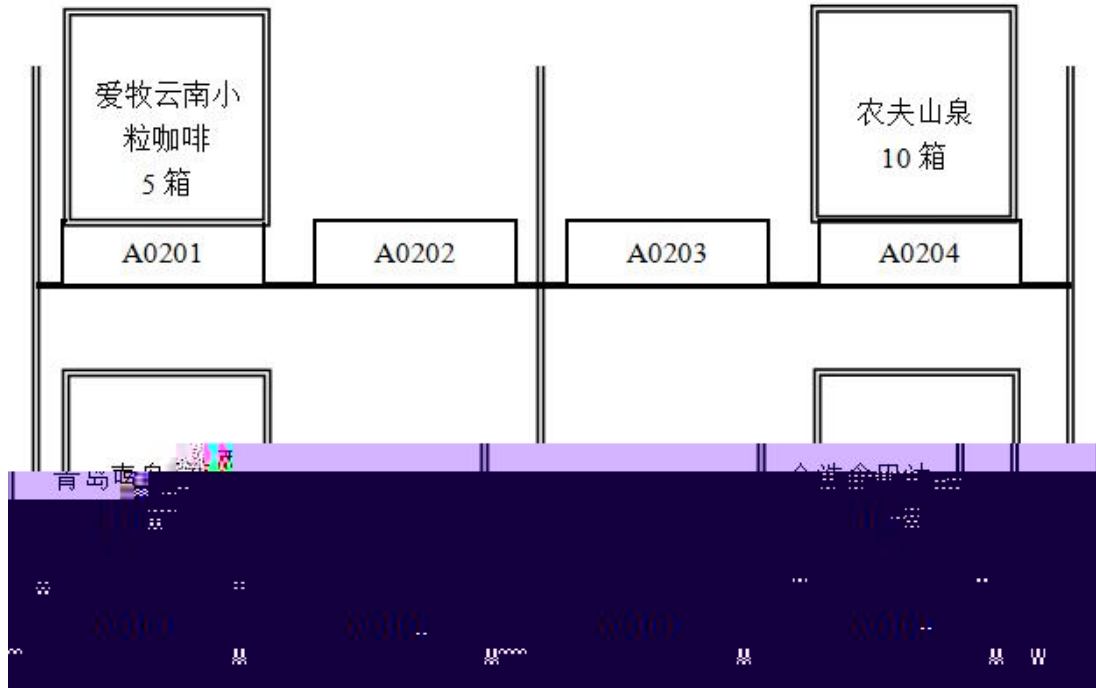

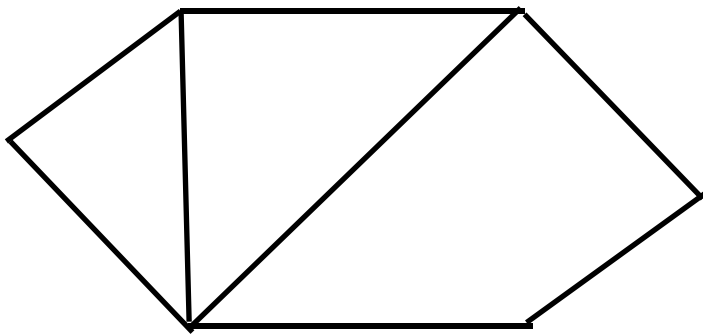

○

○

○

○

○

○

○

○

--	--

○

○

三、国际物流作业组织与管理模块

○

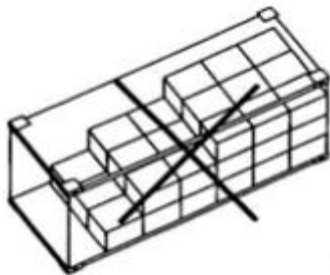
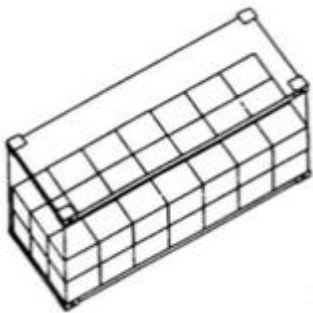

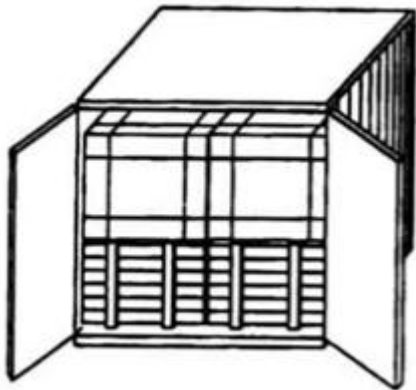
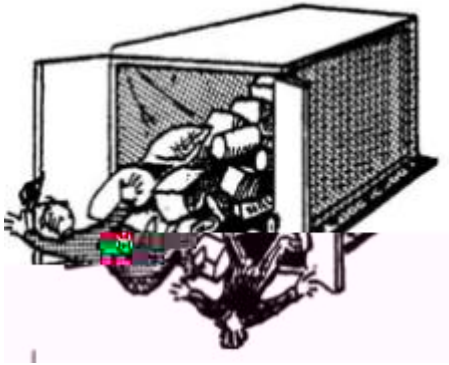
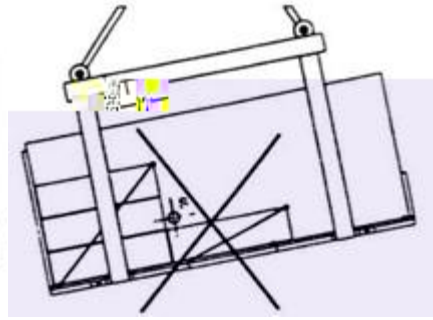
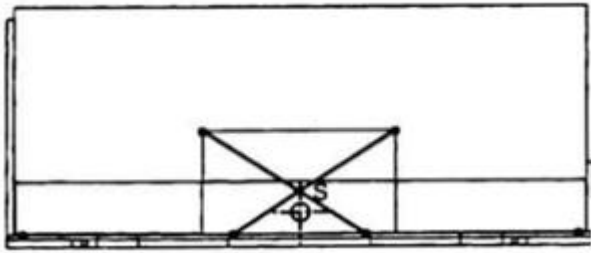

○

船公司 Carrier	船名/航次 Ship Name/Voyage	服务代码 Service Code	航线 Route	装船港/卸船港 Loading/Discharging Port	启-达日期 Start-Arrival Date	天 Days	挂港 Ports
招商局	招商局 001		烟台-威海	烟台-威海	10-10	1	烟台
招商局	招商局 002		烟台-威海	烟台-威海	10-11	1	烟台
招商局	招商局 003		烟台-威海	烟台-威海	10-12	1	烟台
招商局	招商局 004		烟台-威海	烟台-威海	10-13	1	烟台
招商局	招商局 005		烟台-威海	烟台-威海	10-14	1	烟台
招商局	招商局 006		烟台-威海	烟台-威海	10-15	1	烟台
招商局	招商局 007		烟台-威海	烟台-威海	10-16	1	烟台
招商局	招商局 008		烟台-威海	烟台-威海	10-17	1	烟台
招商局	招商局 009		烟台-威海	烟台-威海	10-18	1	烟台
招商局	招商局 010		烟台-威海	烟台-威海	10-19	1	烟台
招商局	招商局 011		烟台-威海	烟台-威海	10-20	1	烟台
招商局	招商局 012		烟台-威海	烟台-威海	10-21	1	烟台
招商局	招商局 013		烟台-威海	烟台-威海	10-22	1	烟台
招商局	招商局 014		烟台-威海	烟台-威海	10-23	1	烟台
招商局	招商局 015		烟台-威海	烟台-威海	10-24	1	烟台
招商局	招商局 016		烟台-威海	烟台-威海	10-25	1	烟台
招商局	招商局 017		烟台-威海	烟台-威海	10-26	1	烟台
招商局	招商局 018		烟台-威海	烟台-威海	10-27	1	烟台
招商局	招商局 019		烟台-威海	烟台-威海	10-28	1	烟台
招商局	招商局 020		烟台-威海	烟台-威海	10-29	1	烟台
招商局	招商局 021		烟台-威海	烟台-威海	10-30	1	烟台
招商局	招商局 022		烟台-威海	烟台-威海	10-31	1	烟台

○
○

BEIJING	CN		BJ\$
Y. RENMINBI	CNY		KGS
		100	100.00
		200	200.00
		300	300.00
		400	400.00
		500	500.00
		600	600.00
		700	700.00
		800	800.00
		900	900.00
		1000	1000.00

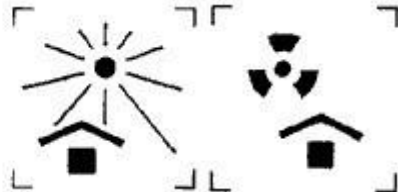
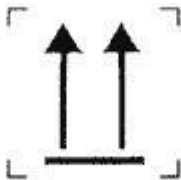
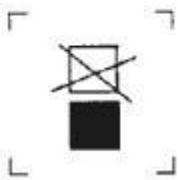

○

○

○

集装箱设备交接单
EQUIPMENT INTERCHANGE RECEIPT

OUT 出场

用箱人/运箱人(CNTR. USER/HAULIER)		提箱地点(PLACE OF DELIVERY)																										
发往地点(DELIVERED TO)		返回/收箱地点(PLACE OF RETURN)																										
船名/航次(VESSEL/VOYAGE No.)	集装箱号(CNTR. No.)	尺寸/类型(SIZE/TYPER)	营运人(CNTR. OPTR)																									
箱号(PLATE No.)	箱号(PLATE No.)	箱封号(SEAL No.)	免费期限(FREE TIME PERIOD)																									
货重(CARGO W.)		出场目的/状态(PPS OF GATE-OUT/STATUS)	进场目的/状态(PPS OF GATE-IN/STATUS)																									
		出场日期(TIME-OUT) 月 日 时																										
出场检查记录(INSPECTION AT THE TIME OF INTERCHANGE)																												
普通集装箱(GP. CNTR.)	冷藏集装箱(REF. CNTR.)	特种集装箱(SEL. CNTR.)	发电机(GEN. SET)																									
<input type="checkbox"/> 正常(SOUND) <input type="checkbox"/> 异常(DEFFECTIVE)	<input type="checkbox"/> 正常(SOUND) <input type="checkbox"/> 异常(DEFFECTIVE)	设定温度(SET) 记录温度(RECORDED)	<input type="checkbox"/> 正常(SOUND) <input type="checkbox"/> 异常(DEFFECTIVE)																									
损坏记录及代号(DAMAGE CODE)																												
<table border="0" style="width:100%; text-align: center;"> <tr> <td><input type="checkbox"/> BR 破损 (BROKEN)</td> <td><input type="checkbox"/> D 凹痕 (DENT)</td> <td><input type="checkbox"/> M 缺失 (MISSING)</td> <td><input type="checkbox"/> OR 污损 (DIRTY)</td> <td><input type="checkbox"/> DL 无标 (NO LABEL)</td> </tr> <tr> <td>左侧(LIFT SIDE)</td> <td>右侧(RIGHT SIDE)</td> <td>前部(FRONT)</td> <td colspan="2">内部(INSIDE)</td> </tr> <tr> <td></td> <td></td> <td></td> <td colspan="2"></td> </tr> <tr> <td>顶部(TOP)</td> <td>底部(FLOOR BASE)</td> <td>后部(REAR)</td> <td colspan="2">如有异常,请注明程度及尺寸(REMARK)</td> </tr> <tr> <td></td> <td></td> <td></td> <td colspan="2"></td> </tr> </table>				<input type="checkbox"/> BR 破损 (BROKEN)	<input type="checkbox"/> D 凹痕 (DENT)	<input type="checkbox"/> M 缺失 (MISSING)	<input type="checkbox"/> OR 污损 (DIRTY)	<input type="checkbox"/> DL 无标 (NO LABEL)	左侧(LIFT SIDE)	右侧(RIGHT SIDE)	前部(FRONT)	内部(INSIDE)							顶部(TOP)	底部(FLOOR BASE)	后部(REAR)	如有异常,请注明程度及尺寸(REMARK)						
<input type="checkbox"/> BR 破损 (BROKEN)	<input type="checkbox"/> D 凹痕 (DENT)	<input type="checkbox"/> M 缺失 (MISSING)	<input type="checkbox"/> OR 污损 (DIRTY)	<input type="checkbox"/> DL 无标 (NO LABEL)																								
左侧(LIFT SIDE)	右侧(RIGHT SIDE)	前部(FRONT)	内部(INSIDE)																									
顶部(TOP)	底部(FLOOR BASE)	后部(REAR)	如有异常,请注明程度及尺寸(REMARK)																									
除列明者外,集装箱设备交接时完好无损,箱封完整无误。 OTHER EQUIPMENT INTERCHANGED IN SOUND CONDITION AND SEAL INTACT UNLESS OTHERWISE STATED																												
用箱人/运箱人签署 (HAULIER'S SIGNATURE)	码头/堆场值班员签署 (TERMINAL/DEPOT CLERK'S SIGNATURE)		CONTAINER 用箱人/运箱人签署 (CONTAINER USER/HAULIER)																									
____年____月____日	____年____月____日		____年																									

--	--	--	--	--	--

--	--	--

--	--	--	--	--	--

--	--	--	--	--	--

--	--	--	--	--	--	--	--

○



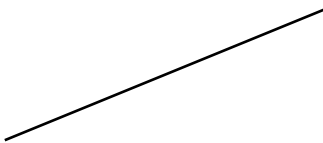

Äc,,TD))PS" U"PQT 0c,,TD P 4ÿ



--	--	--

--	--	--	--	--	--

○

○

○

○

四、 快递物流作业组织与管理模块

--	--	--	--	--	--

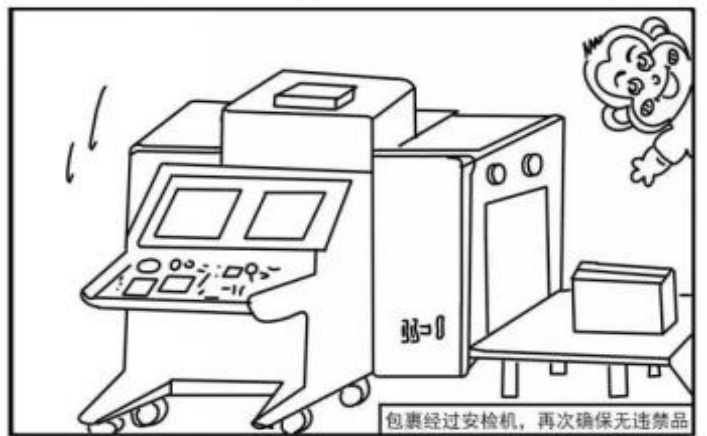

--	--	--	--	--	--

Qs

ELB

--	--	--	--	--	--

[想知道:中国成都理工大学校园快递具体在哪? 百度知道](#)

3个回答 - 提问时间: 2014年02月10日

最佳答案: 韵达在银杏后面。宝盒、圆通、顺丰在电影院后面。中通、申通在图书馆下面。常用的是这几个。

[zhidao.baidu.com/link?... 2014-02-15](#) - 百度快照 - 80%好评

--	--	--	--

--	--	--	--

é : , ' & é é 1° Á Á E ¶ - ? ± » > ð ?

	$i\lambda$	



<hr/>
